

ANALYSIS OF COMPUTER AIDED PROCESS PLANNING TECHNIQUES

Dr. Salim A. Saleh

Lecturer

Mech. Eng. Dept.- University of Tikrit

ABSTRACT

Computer Aided Process Planning (CAPP) has been recognized as playing a key role in Computer Integrated Manufacturing (CIM). It was used as a bridge to link CAD with CAM systems, in order to give the possibility of full integration in agreement with computer engineering to introduce CIM. The benefits of CAPP in the real industrial environment are still to be achieved. Due to different manufacturing applications, many different CAPP

systems have been developed. The development of CAPP techniques needs to a summarized classification and a descriptive analysis. This paper presents the most important and famous techniques for the available CAPP systems, which are based on the variant, generative or semi-generative methods, and a descriptive analysis of their application possibilities.

KEYWORDS: CAPP, CIM, CAD/CAM, Machining.

INTRODUCTION

Process planning can be defined as the function which establishes the sequence of the manufacturing processes to be used in order to convert a part from an initial to a final form, where the process sequence incorporates process description, the parameters for the process and possibly equipment and/or machine tool selection.

The planned process should be

optimum, that is production based on this process should be realized with a specified time and the lowest production cost. All this leads to the need for computerized systems that will allow the process planning function to be performed either totally or partially by a computer, providing the user with optimum process plans in a quick consistent fashion.

Input information for CAPP system

will be formalized part description (half-finished product description and finished part description) and production size. Whereas output information is a formalized description of planned process. First of all this description should contain:

- General information about: part name, part class, drawing of part and its number (code symbol),
- Technological process structure including its elements (technological operations, set-ups, positions, cuts),
- Information for every operation: operation name (string description), operation number (code symbol), production department name (code symbol), work (machining) station name and type (code symbol of work station), part drawing before and after carrying of operation, specification of part fixtures, specification of tool fixtures, kinds and sequence of technological cuts, technical standard operation time, control program,
- Information for every technological cut: word description of cut, its number, kind and type of tool and its characteristic (code symbol), machining parameters for example: cutting speed (V), rotational speed (N), feeding rate (f), main time of cut (machine time).

Components taken into consideration in CAPP are shown in Fig (1).

Characteristic of methods to CAPP

CAPP is carried out with utilization of two major methods:

- Variant method,
- Generative method.

A number of CAPP systems combine both methods, so that a third category is now recognized the *semi-generative method*. It is an interim method to the time of complex development generative method.

Variant method

The variant method of CAPP is comparable with the traditional manual method where a process plan for a new part is created by identifying and retrieving an existing plan for a similar part (sometimes called a master part) and making the necessary modifications for the new part. According to the applied master for identification and retrieval of process plan the following versions of CAPP are used ^[1]:

A. Planning on the basis of a set of individual processes

This method of CAPP provides process plan selection for a given part from the set of individual process plans existing in database ^[1]. Database should be organized in a manner allowing

retrieving it on given set of part features basis (for example specified feature code). The flowchart for process planning procedure on the basis of a set of individual processes is shown in Fig(2).

B. Planning on the basis of a typical process model

Typical process plan is a single common process for the part family, substituting planning of individual processes for every part separately. Part family, for which the typical plan is established, belongs to the *parts technological type*. The parts technological type results from chosen coding and classification system [1,2,3]. Part family consists of the different parts, because the criterions of classification specify only general similarity features.

The flowchart for a procedure of typical process planning is shown in Fig (3). It was developed on the assumption that specified set of parts exist, but process plans for this parts don't exist. Creation of typical process plans database is the result of designing activities.

If it is necessary to develop technological process which does not belong to the set of parts, one should

make an assumption that typical process plan database exist. In this case, procedure of selection typical process from existing database should be realized. The flowchart for this procedure is shown in Fig (4).

One should give attention to correct understanding of typical process plan and its realization in production process that is typical process. Although the process plan is typical, practical realization can be different.

Case I

Plans of so-called *typical basic processes* for the specified part technological type are developed. Process plans consist of general data as a framework. Sets of parts that belong to the given technological type are relatively large. After selection of typical process plan for the specified part from database it is necessary to make its modification by elimination and/or supplement of additional operations. Process realization for every part that belongs to the given technological type has individual character.

Case II

Plans of so-called *typical operative processes* for specified part technological type are developed. In this case, process plan contains the most

essential details concerning specified operations. Process plan concern technological type of parts with considerable similarity that is part which are manufactured with the use of the same basic operations.

There are two kinds of typical operative process plans:

- Plan of typical operative process with homogeneous course in which the process plan can be applied to a not large set of parts that belong to specified technological type and with complete similarity that parts which are manufactured with the use of the same operations. Process realization can be realized on separate work stands and without time relation (scheduling) for every part.
- Plan of typical operative process with homogeneous course and tends to inclusion of additional operations. In this kind of typical process plan allows increasing the number of parts that belong to the given technological type. Their complete similarity is not required as well as the process plan realization can be supplemented by additional operations for some parts.

C. Planning on the basis of a group process model

In the planning on the basis of a

group process model, the set of parts $\{P\}$ intended for machining and corresponding set of features $\{C_P\}$ are divided into groups of technologically similar parts. Synthetic (hypothetical) representative for every technological group is created, that is part that possesses all features of parts which belong to the given technological group. Group process plan for synthetic representative of group is developed. The flowchart for procedure of group process planning is illustrated in Fig (5). If it is necessary to develop process plan for specified part, problem is reduced to selection of suitable group process plan from existing database as illustrated in Fig (6). That requires classification and coding of a given part features and assignment to the specified technological group, for which group process plan exist in database.

After selection of group process plan the next step is its modification by elimination of specified activities (for example cuts).

Course of group process, except operations uniformity, is characterized by operations synchronization, that is part series, that belong to the given technological group, can be machined directly one after another on the same

work stands equipped with suitable technological tooling.

CAPP procedures take also advantage of mixed models as master:

- model of individual process with group operations,
- model of typical process with group operations.

In those cases, courses of technological processes for specified parts must be the same, so as to get to work stands realization of group operations in a specified time.

One of disadvantages of variant method is that the quality of the process plan still depends on the knowledge background of a process planer. The computer is just a tool to assist in manual process planning activities. However, the variant method is still popular. The main reasons probably are:

- The investment in hardware and software is less. Vendors for variant systems are more available now as compared with generative systems,
- The development time is shorter and manpower consumption is lower. Installation is easier than for generative systems,
- It is somewhat more reliable for use in real production environments, so it is reasonable for current production

environments, especially for small and medium sized companies.

Generative method

The generative method process plans are used to automate planning and designing processes. So the CAPP systems perform this task and serve as a bridge between CAD and CAM giving the possibility of full integration in agreement with Computer Engineering [1, 4, 5, 6].

CAPP systems are supporting computer programs for planning technology of the elements of given class. As a result of research work [7,8,9,10] conveyed at the Production Engineering Institute of Cracow University of Technology, a model of the CAPP system for generation method has been developed as illustrated in Fig(7). It uses the expert search techniques in searching to improving the plan of production activities.

The generative method process plans are generated by means of decision logic, formulae, technology algorithms and geometry based data.

Generally, format of input to CAPP systems can be divided in two categories: as a text input, where the user answers a number of questions (defined as interactive input), or as graphic input,

where the part data is gathered from a CAD module (defined as interface input).

Some alternative approaches to generative process planning are used [1]:

A. Decision trees

A decision tree is a graph-tree which comprised of a root and a set of branches originating from the root. In this way paths between alternate courses of action are established. Branches are connected to each other by nodes, which contain a logic operation such as an "and...or" or "IF...THEN" statement. When a branch is true, traveling along the branch is allowed until the next node is reached, where another operation is assigned or an action is executed. Decision trees can call another sub-tree, for example DCLASS, a typical visible tree structure system [1]. Sub-tree can call up to 25 additional sub-trees. Decision trees can either be used as computer code or represented as data. As a computer code, the tree is converted to a flowchart. The starting node is root and every branch represents a decision statement which is either false or true. The rules for the selection of the activities can be presented as a decision tree in Fig (8). Where: D_I - a set of planning decision determining the rules for selection of

activity models for i^{th} level,

T_I - a set of activities models or transitions to the other planning decisions for i^{th} level,

R_I - relations defined on the set of planning decisions $d_{I1}, d_{I2}, d_{I3}...$ D_I and activities models $t_{I1}, t_{I2}, t_{I3}...$ T_I for the i^{th} level,

$I = 1...N$, N - number of levels.

Each operation model $t_{I1}, t_{I2}...$ T_I can be described using the net of the lower level.

The root of which is created by the selected attribute Q of the planning task, and the particular branches represents the values of this attribute q . The graph nodes on the higher levels of the tree have assigned further attributes occurring in the classification task, whereas the nodes on the lowest level describe the corresponding activities. The actions can be described by means of the net of the lower level.

Decision trees have certain definite benefits over decision tables:

- trees can be updated and maintained more easily than can decision tables,
- selected branches of the decision tree may be extended to a considerable depth if necessary, while other branches may be quite short, which is more difficult to do with decision tables,

- some branches of the decision tree may be used to define TYPE, and others ATTRIBUTES, which results in relatively small trees,
- trees are easy to customize, visualize, develop and debug.

B. Decision tables

Decision tables organize conditions, actions and decision rules in tabular form. Conditions and actions are placed in rows while decision rules are identified in columns. The upper part of the table includes the conditions that must be met in order for the actions (represented in the lower part of the table) to be taken. Decision table should contain the actual rules conditions specified in the design. According to the rule representation, decision tables can be classified as follows:

- limited entry decision tables that represent the exact conditions (input values) as true or false entries,
- extended entry decision tables that specify the condition but not the value,
- mixed entry decision tables whereby sequenced and un sequenced actions can be entered. Sequenced actions rate a sequence number while un sequenced actions do not rate one.

C. Axiomatic approach

Its intention is to provide a logical

framework for designing products and processes. A set of desired characteristics of the design, known as *functional requirements (FRs)*, must be defined to establish a *design range*. A set of *design parameters (DPs)* must also be identified so that the system range can be defined. Axiomatic approach to process planning is used to define and simplify the relation between the *FRs* and *DPs* through a set of axioms. The entire framework is based on two axioms:

- Axiom 1 - The independence axiom - **Maintain the independence of functional requirements,**
- Axiom 2 - The information axiom - **Minimize the information content.**

To implement axiomatic design in process planning, the following steps are applied:

- 1) List all the design (or production) parameters to be evaluated,
- 2) Divide the surfaces to be produced into surface groups, each of which is to be machined by a single machine,
- 3) List candidate machines for each surface group,
- 4) Evaluate all alternatives for the production and machine parameters,
- 5) Obtain the total information content and select the best machine combination based on the information content.

D. Artificial intelligence technique and expert systems

Artificial intelligence techniques like formal logic, describing components and expert systems for codifying human processing knowledge are also applicable to process planning problems.

Due to the rapid development artificial intelligence techniques, generative process planning systems are built as expert systems with technological knowledge representation, which specifies general and detailed rules of process planning. They have involved object-orientated programming techniques and virtual single manufacturing database techniques. Some new generation systems have employed fuzzy logic and neural network techniques and machine learning approach ^[11, 12].

The major areas of activities in generative approach to process planning are:

- determination of part characteristic,
- semi-product designing,
- elementary activities selection,
- machine selection,
- technological instrumentation selection,
- technological operation sequencing,
- tool selection,

- machining parameters selection,
- time and cost calculation.

Examples of developed generative process planning systems are APPAS, CMPP, EXCAP, XPLAN.

Semi-generative method

Semi-generative method is interim approach used when problems in building purely generative process planning system have occurred. The semi-generative method can be characterized as an advanced application of variant technology employing generative type features. Systems utilizing semi-generative method to process planning should co-operate with planner, who possesses technological knowledge. The planner's responsibility is the interpretation of decision data and/or working drawing. There are following ways of this method:

- the variant method can be used to develop the general process plan, then the generative method can be used to modify,
- generative method can be used to create as much of the process plan as possible then the variant method can be used to fill in the details,
- process planner can select either generative mode for complicated part

features or variant mode for fast process plan generation.

The following process planning activities are subsequently realized in this method:

1) Selection of a generalized structure of the manufacturing process

The generalized structure of the manufacturing process is selected based on the processing and geometrical characteristics of the product in Fig (9). The product is evaluated taking into consideration the values of its attributes, according to the sequence resulting from the structure of the decision tree. Using such reasoning the activity (i.e. the selection and transition to manufacturing process planning on the basis of chosen structure) can be determined [8].

2) Reversible planning of the semi-finished product and intermediate shapes of the product

The elements of the generalized structure, i.e. stages and phases, are the basis for determining so called intermediate states describing the shape and processing properties of the work-piece. These states are to be achieved as the result of an appropriate (i.e. consistent with assumed phase-stage structure, see description of the level II÷N-1 manufacturing knowledge)

execution of the machining process. On the basis of geometrical and processing characteristics of the product and the manufacturing knowledge the intermediate shapes and the semi-finished product may be determined by using the reversible method.

As shown in Fig (10), this stage is realized in the following steps:

- determination of the type of the semi-finished product,
- planning of the intermediate shapes of the product
- design of semi-finished product.

3) Generating the machining process

For each determined in the previous planning step planning objective the task can be formulated in the following way: Choose the methods and means leading to an intermediate state for a given stage and phase.

For the planning objective the decision-making process will be realized in an iterative way as illustrated in Fig (11). The process is generated in the following steps:

- identification of allowances;
- selection of the range of machining;
- selection of the work-piece fixture variant;
- identification of the stand structure from the view of the product;

- selection of machine tool ;
- definition of product location;
- selection of set-up;
- identification of variants of shape change;
- identification of stand structure from the view of tools;
- selection of variants of shape change;
- selection of tool ;
- definition of parameters for the machining variant.

After defining the model of shape change and the way, in which it is obtained, the transformation of the work-piece shape and processing properties is carried out. The process will be repeated until the intermediate shape, which corresponds to the realized goal is obtained.

CONCLUSIONS

We have tried to summarize the main conclusions:

1. The advantages of CAPP are typical of those accrued when any procedure is automated via computers. A brief list of these advantages are: reduced clerical effort, fewer calculations, fewer oversights in logic, immediate access to up-to-date information, consistent information, faster response to engineering or production changes, use

of latest revisions, more detailed and uniform planning, more efficient use of resources.

2. While the variant method has advantage of mixing each of individual process and typical process with group operations, it still depends on the knowledge of process planner.

3. Generative method tends to employing the rapid development in computer and software engineering by using their efforts in:

- The decision tree is more suitable to be used in generative method; since it can be updated, maintained, customized, visualized, developed and debugged easier than decision tables.

- It uses the artificial intelligence techniques, to be built as expert systems with technological knowledge representation.

- Some new generation systems have began to employ fuzzy logic and neural network techniques and machine learning approach.

4. Semi-generative method stills used as a key to build purely generative process planning system, in spite of its co-operation with planner in the interpretation of decision data and/or working drawing.

REFERENCES

- [1] Zhang H. C., Alting L. "Computerized Manufacturing Process Planning Systems", Chapman & Hall, 1994.
- [2] Houtzeel A. "The MICLASS System. Proceedings of CAM-I's Executive Seminar-Coding, Classification and Group Technology for Automated Planning", CAM-I, Arlington, Texas. 1976.
- [3] Opitz H. "A Classification System to Describe Work-pieces", Part I, Pergamon Press, UK, 1970.
- [4] Chang, T.Ch. "Expert Process Planning for Manufacturing", Addison-Wesley Publishing Company, 1990.
- [5] Kiritis, Dimitris, "A Review of Knowledge - Based Expert Systems for Process Planning, Methods and Problems", International Journal Advanced Manufacturing Technology, pp. 240-262, Springer - Verlag, London, 1995.
- [6] Leung Horris, C. "Annotated Bibliography on Computer-Aided Process Planning", International Journal Advanced Manufacturing Technology, pp. 309-323, Springer - Verlag, London, 1996.
- [7] Duda, J., Habel, J. and Poboziak, J. "Control mechanism of expert system with representation of knowledge in the form of hierarchical decision nets", 12th International Conference On Applications Of Artificial Intelligence In Engineering, AIENG XII. Wessex Institute of Technology UK, Capri, Italy July 1997.
- [8] Duda, J. and Samek, A. "Formalization of activities in computer aided process planning", 7th International Machine Design and Production Conference, METU, ANKARA, TURKEY, 1996.
- [9] Duda, J., Habel, J. and Poboziak, J. "Prototype of CAPP system based on expert system technology", International Symposium "Advanced Manufacturing Processes, Systems and Technologies", University of Bradford, UK, March 1996.
- [10] Duda, J., Habel, J., Kwatera, M. and Samek, A." Data Base with open architecture for defining Manufacture System Capabilities", Flexible Automation & Intelligent Manufacturing FAIM'99, Tilburg, Holland 23-25 June 1999.
- [11] Lu S.C.-Y., Zhang G. "A combined inductive learning and experimental design approach to manufacturing operation planning", Journal of Manufacturing Systems, 9(2) 1990.

- [12] Tonshoff, H.K., et al., "Integrated Process Planning and Production Control Based on the Application of Intelligent Agents", Proceedings of the 3rd CIRP International Seminar on Intelligent Computation in Manufacturing Engineering- ICME 2002, 3-5 July, Ischia, Italy, pp. 135-140.

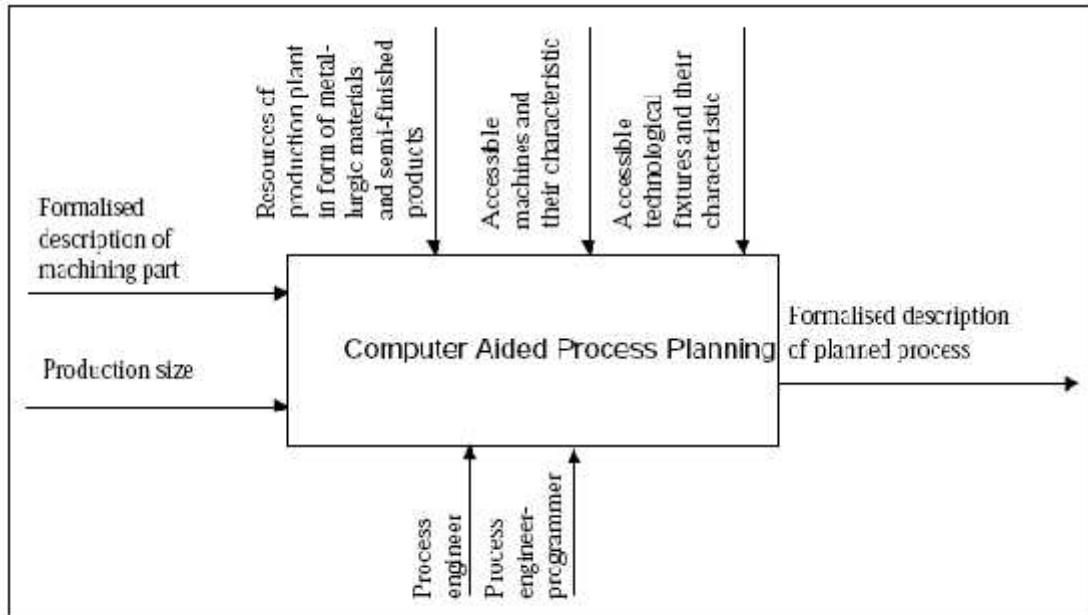

Fig. 1. Components taken into consideration in computer aided process planning

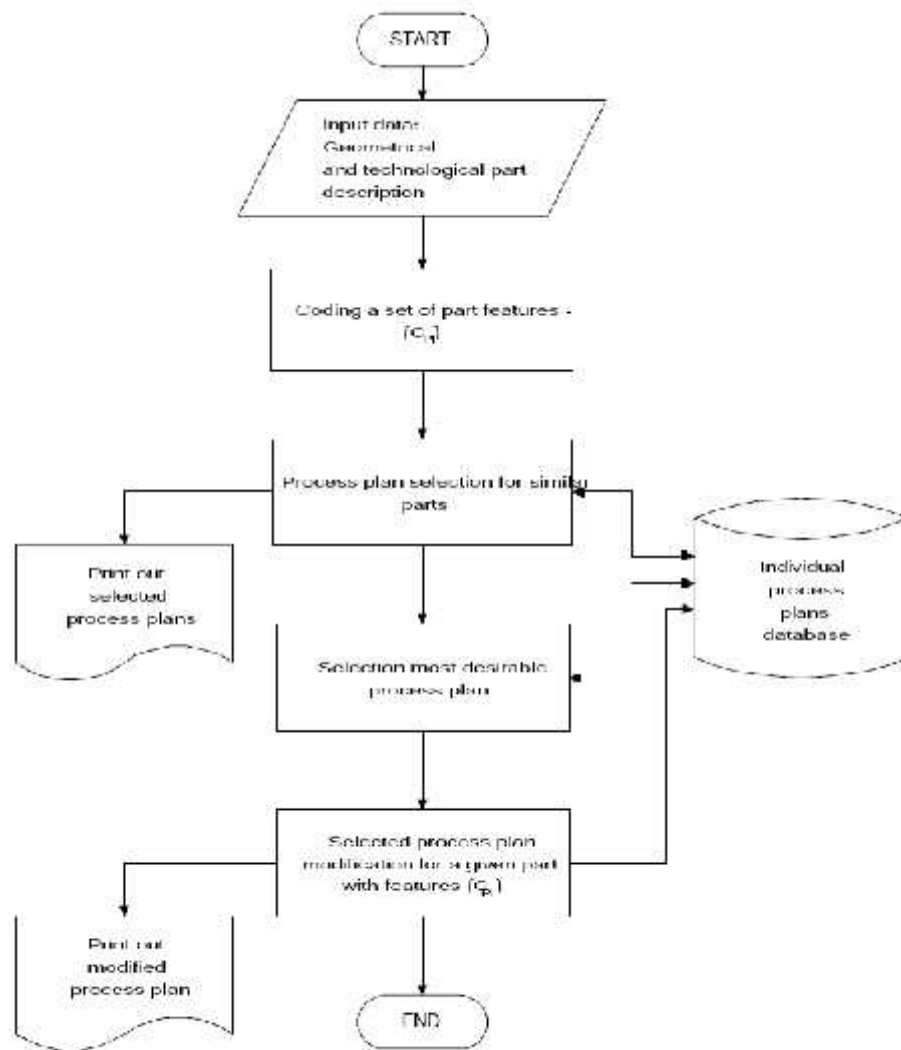

Fig. 2. The flowchart for process planning procedure on the basis of a set of individual processes

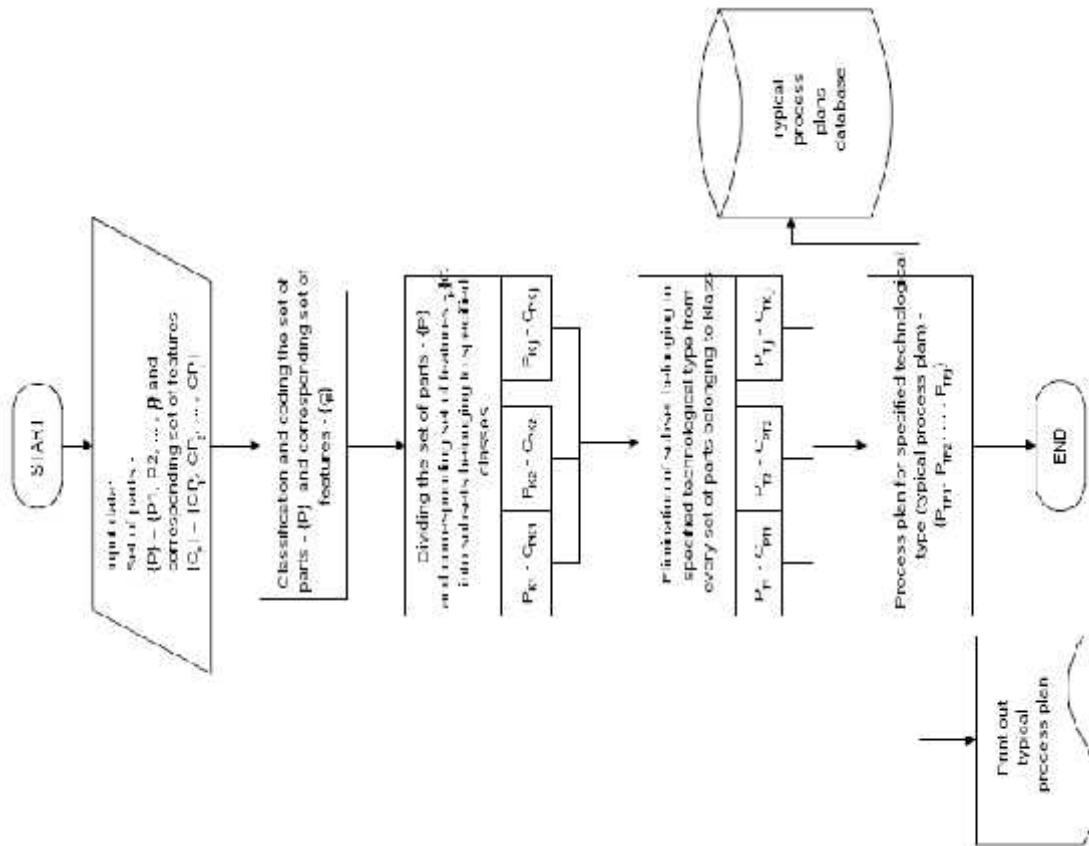

Fig. 3 The flowchart for procedure of standard process planning

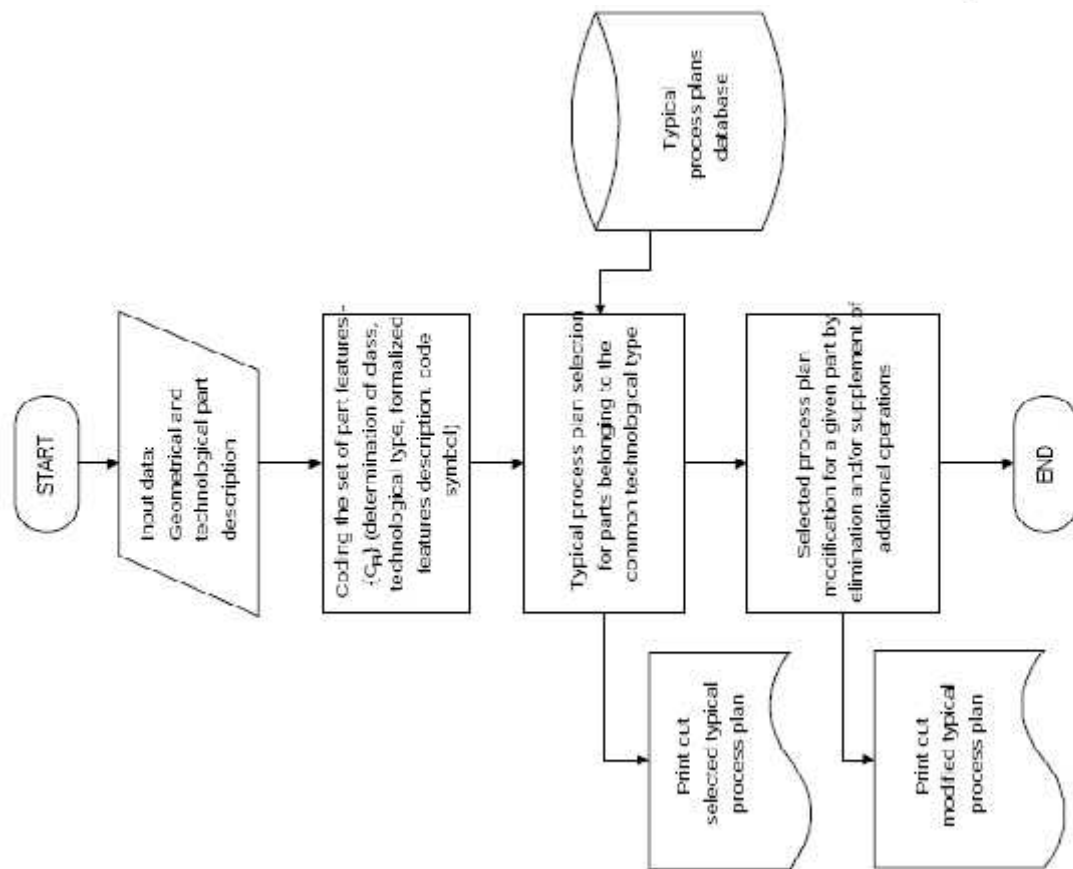

Fig. 4 The flowchart for typical process plan selection

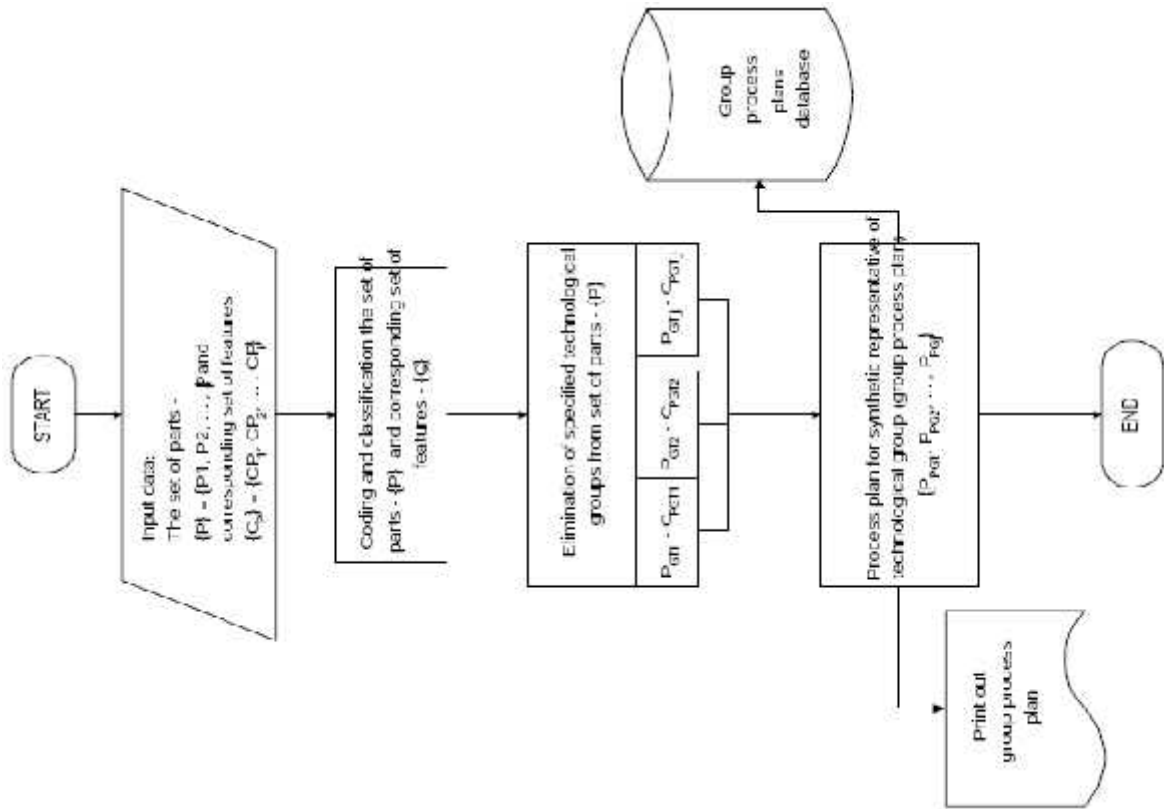

Fig. 5. The flowchart for procedure of group process planning

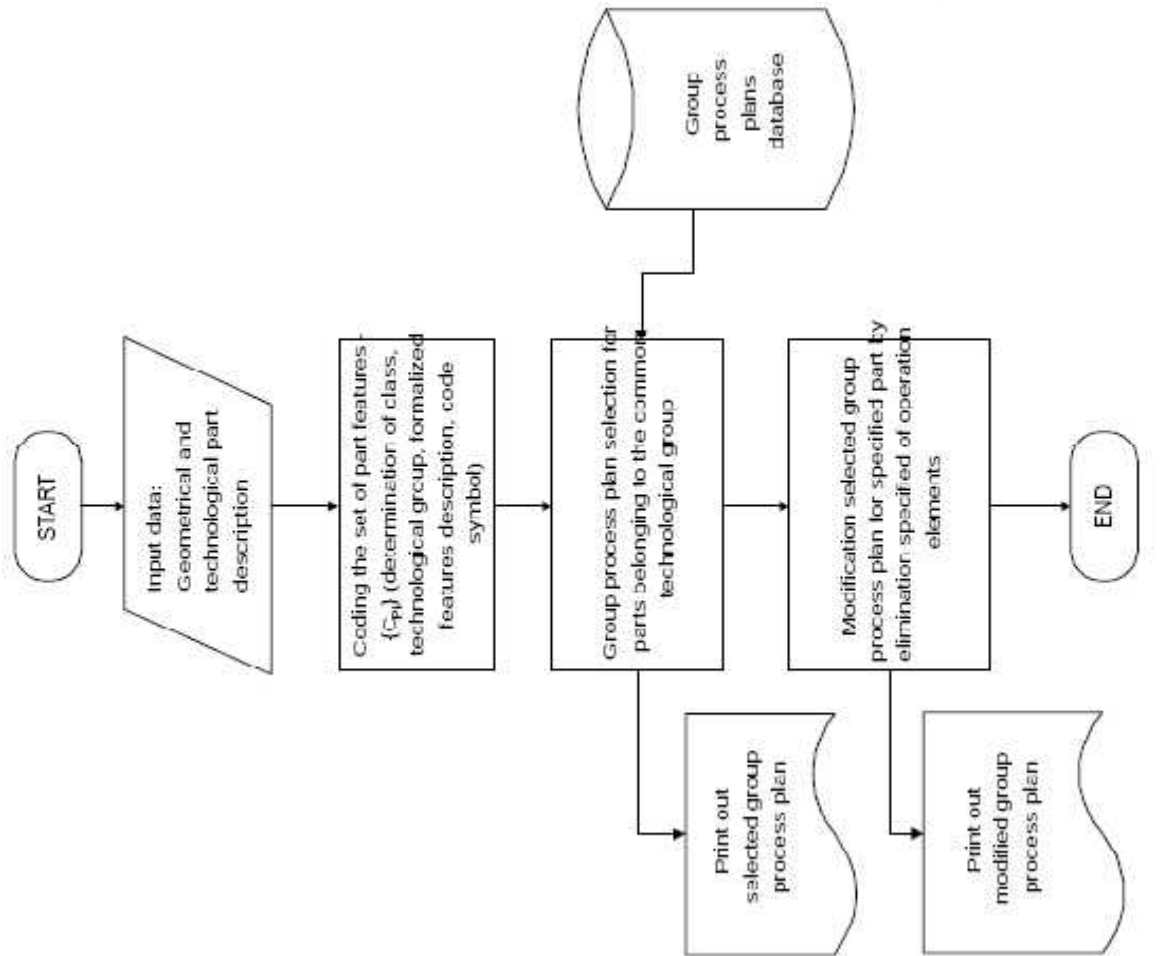

Fig. 6. The flowchart for select procedure of group process plan

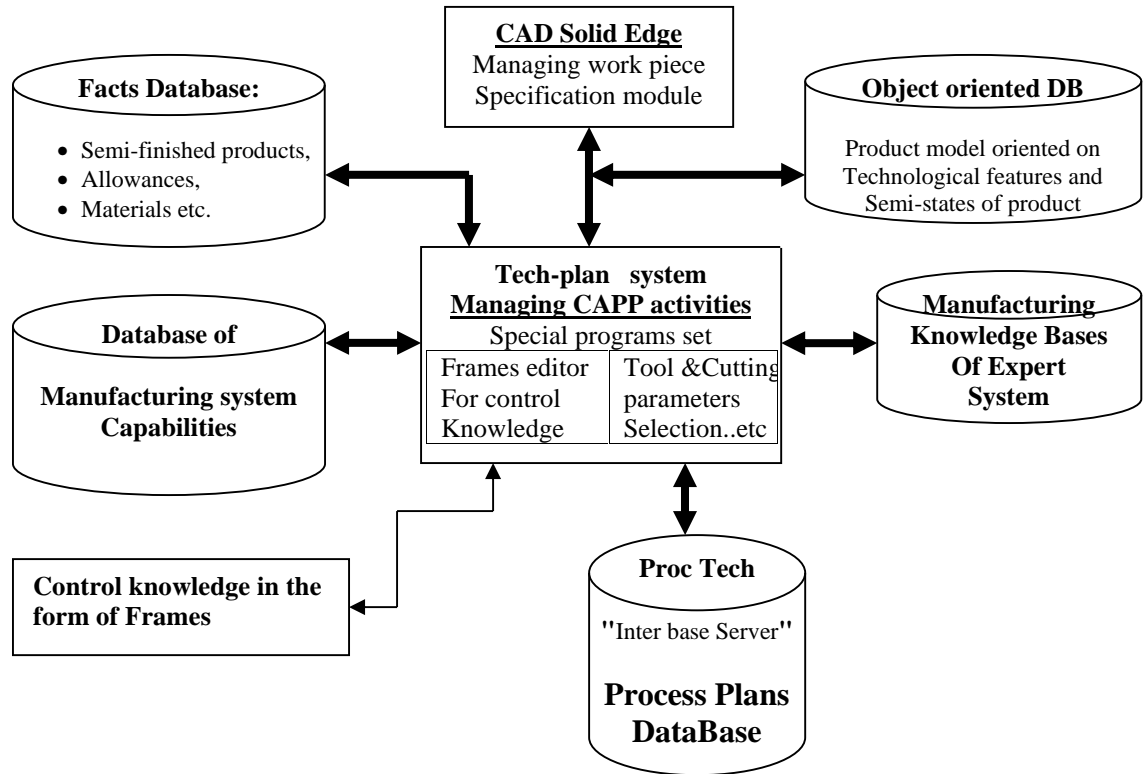

Fig.7. CAPP system architecture for generative method

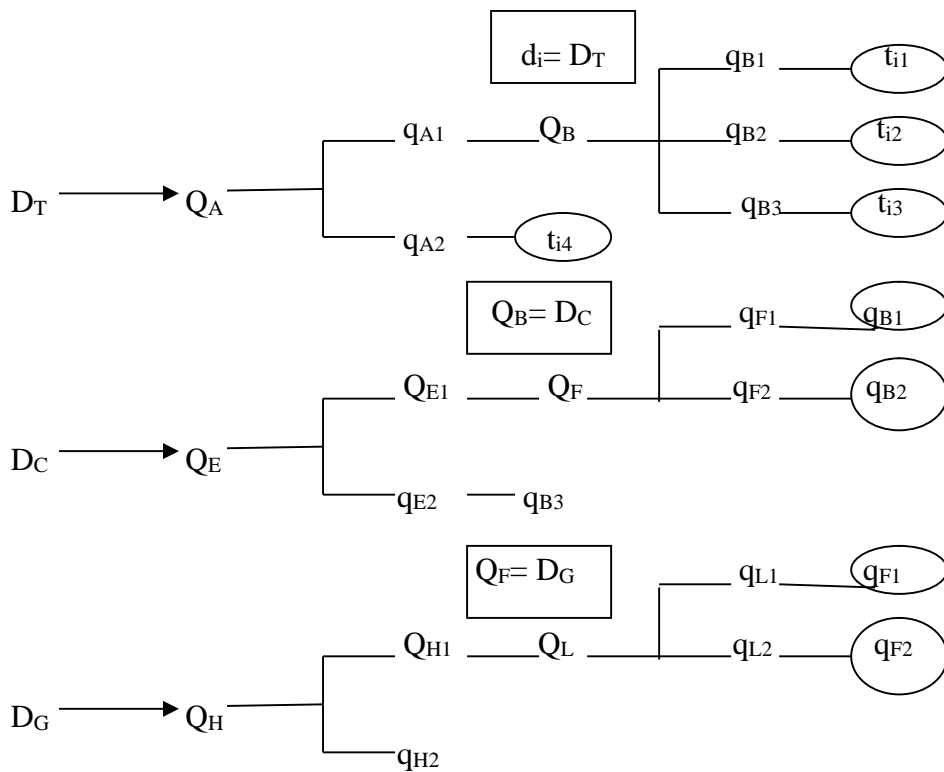

Fig. 8. The decision tree.

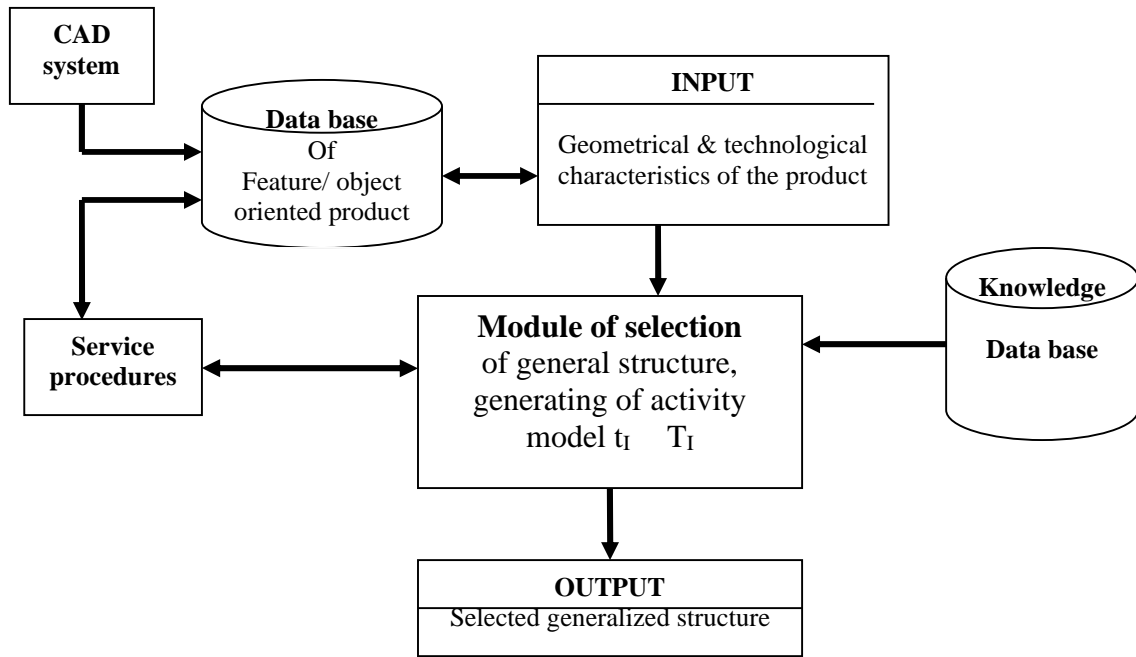

Fig. 9. Selection of a generalized structure of the manufacturing process

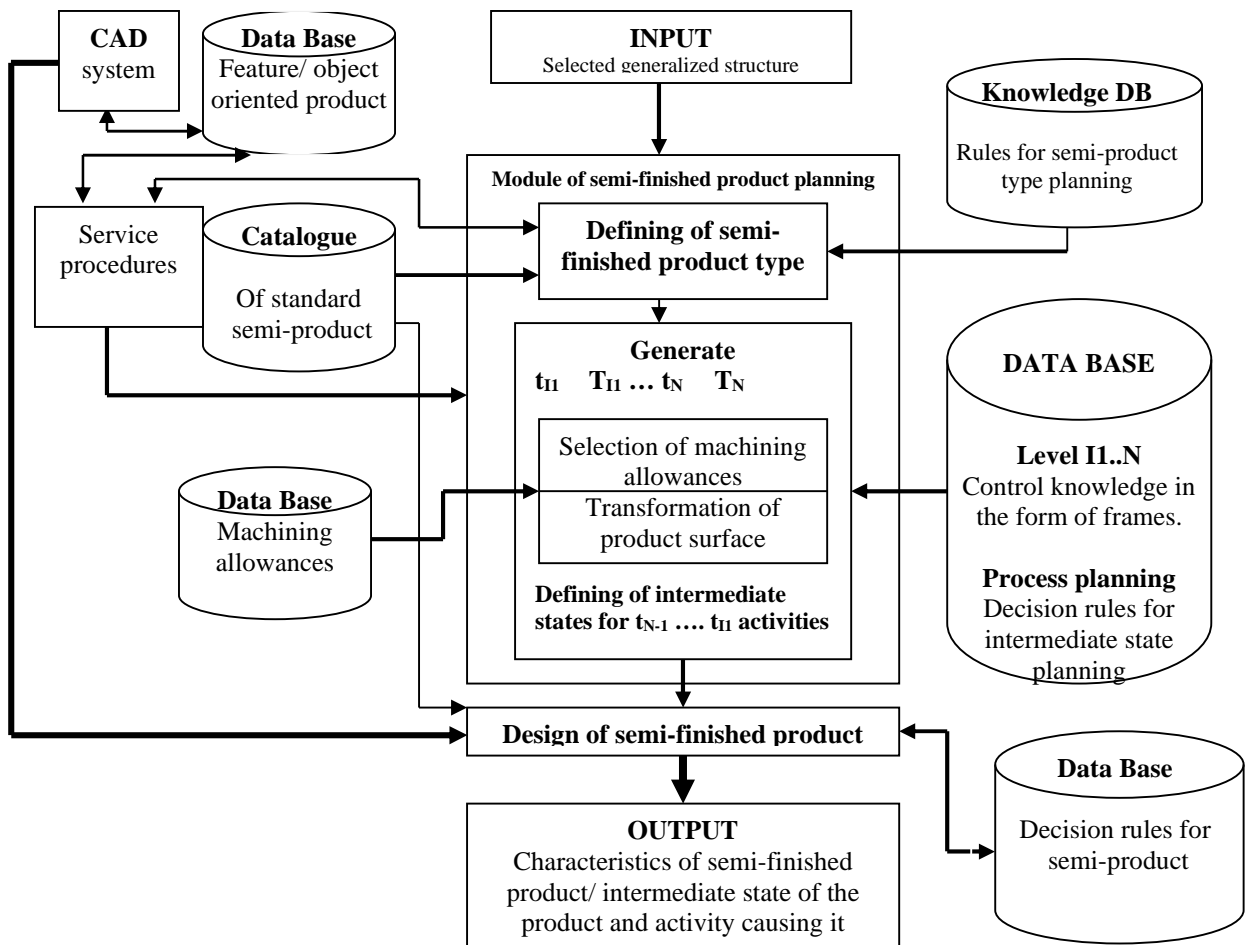

Fig. 10. Reversible planning of the semi-finished product and intermediate shapes of the product

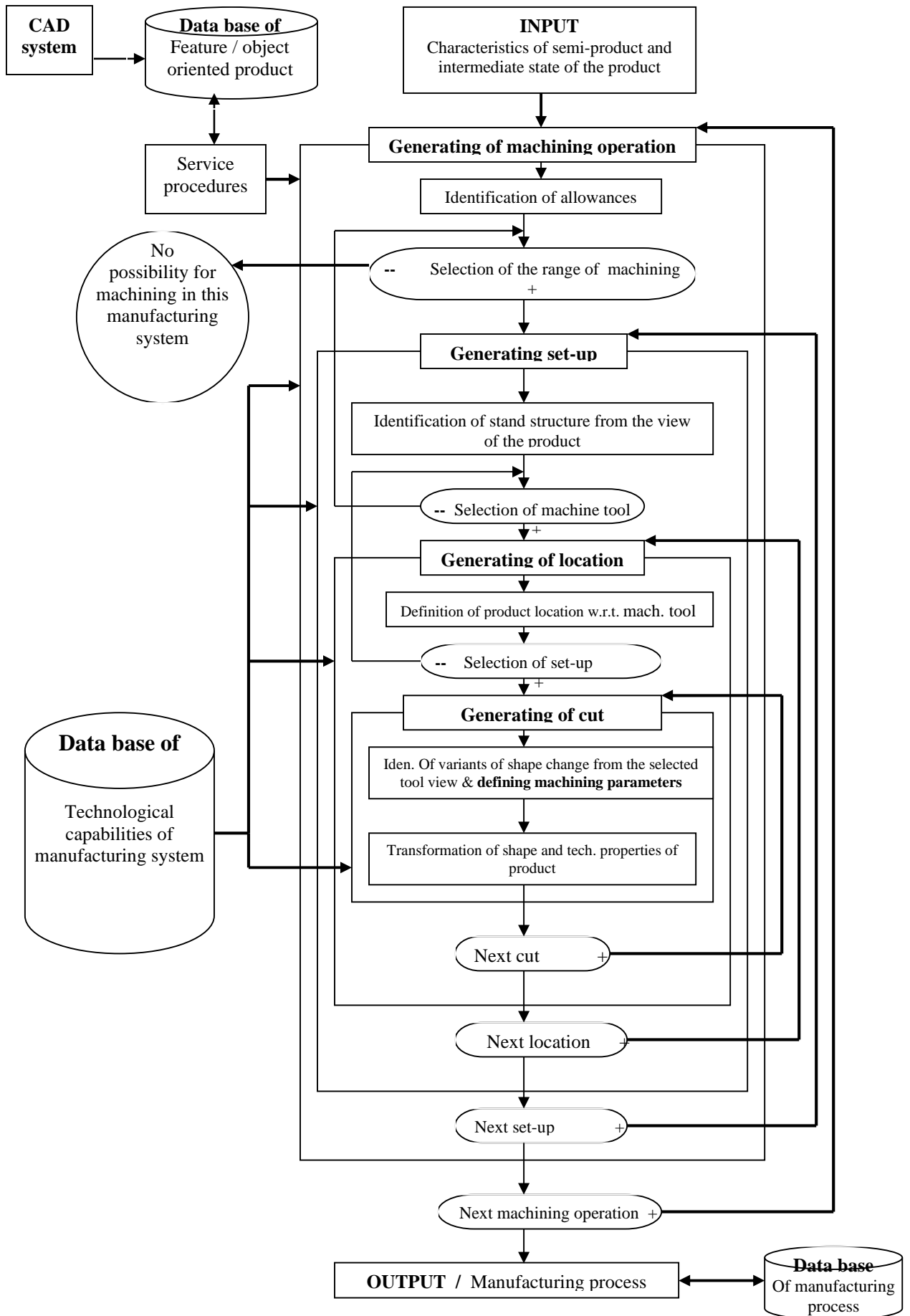

Fig. 11. Generating the machining process

تحليل تقنيات تخطيط العمليات المعان بالحاسوب

م . د . صالح الدليمي

د

قسم الهندسة الميكانيكية - كريت

د

عرف تخطيط العمليات المعان بالحاسوب (CAPP) بأنه يلعب الدور الرئيسي في أتمتة الإنتاج المتكامل (CIM). فهي تستخدم كجسر لربط أنظمة التصميم المعان بالحاسوب (CAD) بأنظمة الإنتاج المعان بالحاسوب (CAM) لأجل توفير إمكانية تحقيق أتمتة الإنتاج المتكامل (CIM) المتقنة مع هندسة الحاسوب ذات التقدم المضطرد. لا تزال منافع التخطيط المعان بالحاسوب (CAPP) تتحقق في البيئة الصناعية الحقيقية. التطبيقات الصناعية المختلفة، كانت سببا لتطوير العديد من نظم تخطيط العمليات المعان بالحاسوب (CAPP). في (CAPP) المطورة تحتاج تصنيفا متكاملا وتحليلا وصفيًا لتلك . تقدم هذه الورقة تحليلا في التطبيقية العملية لتقنيات ذات مبر والشهرة بين نظم تخطيط العمليات المعان بالحاسوب (semi-) تستند على الطرق التوزيعية (variant) وابتدئ (generative) شبه التوليدية (semi-) (generative).

كـ مـ د : تخطيط العمليات المعان بالحاسوب، التصميم والإنتاج المعانين بالحاسوب، أتمتة الإنتاج المتكامل، التشغيل الميكانيكي.