

ISSN: 1813-162X (Print) ; 2312-7589 (Online)

Tikrit Journal of Engineering Sciences

available online at: <http://www.tj-es.com>
TJES
 Tikrit Journal of
 Engineering Sciences
Ziyad K. Farej¹Ali M. Abdul-hameed^{2, *}
¹ Dept. of Medical Instrumentation Eng.
 Tech. College
 Northern Tech. University
 Mosul, Iraq

² Dept. of Computer Technical Eng.
 Tech. College
 Northern Tech. University
 Mosul, Iraq

Tikrit Journal of Engineering Sciences

A Performance Evaluation of IEEE 802.15.4 Based on Wireless Sensor Network for Small-Scale Application

ABSTRACT

This paper evaluates the performance of IEEE 802.15.4 standard Wireless Sensor Networks (WSN) in star topology of small scale applications. The performance of the network is analyzed in terms of end to end delay, maximum throughput and number of network devices with respect to the payload. This analysis which is devoted for biomedical applications is performed theoretically and compared with a practical analysis using the network simulator Opnet modeler (version 14.5) in order to validate this theoretical analysis.

© 2017 TJES, College of Engineering, Tikrit University

DOI: <http://dx.doi.org/10.25130/tjes.24.3.04>

Keywords:

Electric power distribution substation
 electromagnetic field
 health effect

ARTICLE INFO

Article history:

Received 16 January 2017
 Accepted 02 May 2017
 Available online 30 September 2017

حساب وتحليل شدة المجالات الكهرومغناطيسية داخل محطه فرعيه لتوزيع الطاقة الكهربائية

الخلاصة

تعتبر المحولات الكهربائية العنصر الأساسي في شبكة نقل وتوزيع الطاقة الكهربائية لذا فهي تعتبر مصدر لانبعاث الإشعاعات الكهرومغناطيسية والتي يمكن ان تؤثر على صحة العاملين في محطات التحويل. تم في هذا البحث قياس مستويات المجالات الكهربائية والمغناطيسية الناجمة عن تشغيل محطات توزيع الطاقة الكهربائية 132 /33 كيلو فولت كما تم تحديد المسافات الآمنة من بعض الأجهزة بهدف تجنب التعرض المستمر لهذه الإشعاعات من قبل العاملين. تم اجراء القياسات بطريقتين: الحسابات الرياضية والقياسات العملية. مقارنة النتائج الحاصلة مع الحدود الآمنة المسموح بها دوليا المحدد من قبل منظمة الصحة العالمية تبين عدم وجود مخاطر على صحة العاملين في تلك المحطات اذا كان التعرض لفترات قصيرة ومتقطعة.

1. INTRODUCTION

WSN is a composed of sensor nodes with special function that exchange information by self-organizing wireless communication and do as a certain function together. IEEE 802.15.4 agreement with low rate is intended in order to get low cost and low power in the industrial automation, intelligent households and medical applications...etc. Therefore, the study of its performance is necessary for its design [1]. Because of the rapid development of the wireless communication, integrated circuit sensor and MEMS, the mass production of tiny sensor nodes with the function of the wireless communication, and data acquisition, processing and collaboration become possible [2]. IEEE 802.15.4 standard is a very reliable wireless connection protocol and among

the inexpensive devices either fixed or portable like sensor based or home networks and WBAN [3].

Liang and Balasingham [4] studied the effect of (CSMA/CA) random access mechanism, network devices number, sampling rate and the cycle of the transmission. The performance metrics, which consists of packet delivery rate, end to end latency, and transmission delay, are also analyzed. Latré et al. [3] studied the minimum delay and maximum throughput of IEEE 802.15.4 standard by mathematical analysis. Their experiments are conducted by using only one Tx and one Rx network. The IEEE 802.15.4 performance is analyzed for WBAN [5], the analysis focused on the long term power consumption of the sensors. The evaluation and comparison of IEEE 802.15.4 standard performance using Omnet++ simulator is performed with the focus on single sink scenario, in terms of data delivery rate, goodput, throughput and error rate metrics [6].

* Corresponding author: E-mail : ali.maahr@gmail.com

In this paper a star topology is considered because of the convenience of this single-hop network for delay critical applications especially for biomedical applications. The theoretical performance analysis is implemented and evaluated practically for small-scale star topology WSN. These analyses include the investigation of the impact of increasing the number of nodes and payloads on throughput and end to end delay. For the rest of the paper the expression simulation and practical analysis were used interchangeably.

This paper is organized as follows: Section 2, gives small idea about the IEEE standard (802.15.4). In section 3, the performance analysis, which consists of the theoretical analysis of end to end delay and maximum throughput with respect to payload and number of nodes for small scale network devices, is given. In section 4, the practical results and graphs are given. Finally, section 5 shows the conclusion and the suggestions for future researches.

2. IEEE 802.15.4 OVERVIEW

The 802.15.4 IEEE standard defines (PHY) and (MAC) sub-layer Fig. 1 shows its structure [7]. This structure includes the application layer, the network layer and the physical layer. Data transmission and reception, channel selection, determination of link quality, channel sensing and the setting of node state, are performed at the physical layer, where an interaction with wireless channel is also accomplished so that information from and to the upper layer is supplied. This function is important for (CSMA/CA) mechanisms.

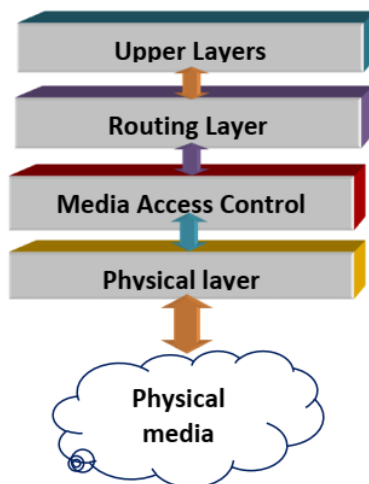


Fig. 1. 802.15.4 System structure.

Energy detection scan (ED) and clear channel assessment (CCA) are performed by the protocol. In the Industrial Scientific Medical (ISM) there are three frequency bands [8]:

- In the 868 MHZ, there is 1 channel with 40 Kbps data rate.
- In the 915 MHZ, there are 10 channels with 40 Kbps data rate.
- In the 2.4 GHZ, there are 16 channels with 250 Kbps data rate.

An interface between upper layer and physical layer is provided by standard MAC layer. The management of the link, security, channel access, frame validation and

nodes synchronization are handled. Star and peer to peer are the two types of topologies that are supported by IEEE 802.15.4, see Fig. 2.

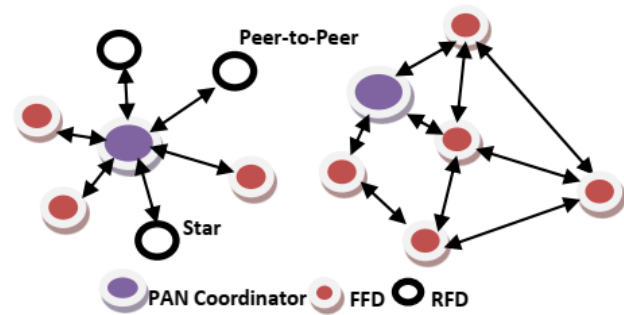


Fig. 2. Star and peer-to-peer topology examples.

MAC protocol in IEEE 802.15.4 can operate in both beacon enabled (slotted) and non-beacon mode (unslotted). In the beacon enabled mode, the control of communication is done by the network coordinator which transmits a periodic beacon. A superframe structure, which consists of inactive and active periods, is used. The active one consists of 16 slots of equal size and contains two periods: Contention Free Period (CFP) and Contention Access Period (CAP). In CAP, the used channel access mechanism is slotted (CSMA/CA), while, in CFP time slots are assigned by coordinator. When the mode of the non-beacon is enabled there is no transmission of beacons, and the channel access mechanism is made through unslotted (CSMA/CA). RTS/CTS handshake is not included in (CSMA/CA), although it is an important mechanism for the channel access, because of the low data rate that used in the standard; the transmission happens when the condition is suitable (no activities). Otherwise, algorithms will backoff for a bit of time before assessing the channel again.

3. PERFORMANCE ANALYSIS

The performance of IEEE 802.15.4 will be analyzed in terms of end to end delay and maximum throughput. The focus will be on single-hop star topology, because it is the most suitable for delay critical applications, while in a peer to peer network topology, mesh type and cluster tree are used, where the coordinators may communicate with each other and route the messages in a multi-hop way to the coordinators outside its range, this causes an increase in the network latency due to message relaying [7].

3.1. End to End Delay and Throughput Theoretical Analysis

The end to end delay is defined according to the following equation [4]:

$$T = TBO + T_{packet} + TTA + TACK + TIFS \quad (1)$$

where T is the needed time to transmit a packet from the node to the coordinator in one second, and includes the backoff period. TTA is the transceiver's transmitting to receiving turnaround time. TIFS is the time of Inter Frame Space. There are two types of (IFS); Short Inter Frame Space (SIFS) and Long Inter Frame Space (LIFS). The (SIFS) is used with small packet size; smaller or equal to 18byte. (SIFS=192 μ s, LIFS=640 μ s). T_{packet} is the time

needed to transmit one packet, TACK is the time for sending an Acknowledgment 864μs [6]. TBO is the sum of average backoff period. The frame structure and Frame transmission sequence can be seen in Fig. 3 and Fig. 4 respectively, and also the parameters network are shown in Table 1.

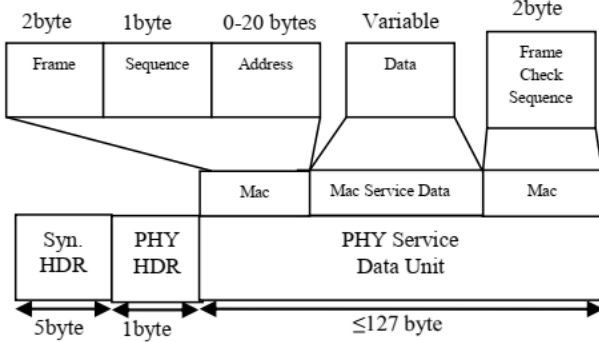


Fig. 3. Frame structure of IEEE 802.15.4.

where b is the maximum backoff periods (with limitation up to 5). R is the average backoff period and is given by the following Eq. (4) [4]:

$$R = (1 - P_s)b + \sum_{a=1}^{a=b} a P_c (1 - P_c)^{(a-1)} \quad (4)$$

- The average time of the back off period ($T_{BOP}(a)$) can be calculated as follows [4]:

$$T_{BOP}(a) = \frac{2^{macMinBE+a-1} - 1}{2} T_{BOSlot} \quad (5)$$

where mac-Min-BE is the minimum default value which is equal to 3, and TBOSlot is the duration of one backoff slot.

- Finally, the total average backoff time, TBO, is calculated as follow [4]:

The Tpacket can be calculated as follows [3]:

$$T_{BO} = FractionalPart[R] T_{BOP}(IntegerPart[R] + 1) + \sum_{a=1}^{a=IntegerPart[R]} T_{BOP}(a) \quad (6)$$

$$T_{Packet}(x) = 8 \times \frac{L_{PHY} + L_{Mac_HDR} + L_{Address} + x + L_{MAC_FTR}}{DataRate} \quad (7)$$

Table 1

Parameters of network device.

Parameters	Value
TBOSlot	320 μs
TTA	192 μs
TSIFS	192 μs
TLIFS	640 μs
LPHY	6 bytes
LMHR	11 bytes
LMFR	2 bytes
macMinBE	3
MaxBE	5
macCSMABackoffs	4

The TBO can be determined as follows:

- For a network consisting of (n) devices with probability (q) a channel can transmit data at anytime, then at the end of backoff period the probability that a network device assesses the channel idle is given by Liang and Balasingham [4]:

$$P_c = (1 - q)^{n-1} \quad (2)$$

- P_s (probability that the device can successfully access the channel) may be calculated according to the following Eq. (3) [4]:

$$P_s = \sum_{a=1}^{a=b} P_c (1 - P_c)^{(a-1)} \quad (3)$$

where the lengths (L_{PHY} , L_{Mac_HDR} , $L_{Address}$ and L_{MAC_FTR}) are shown in Fig. 3.

TACK is calculated using the following Eq. (8) [3]:

$$T_{ACK} = \frac{L_{PHY} + L_{Mac_HDR} + L_{MAC_FTR}}{DataRate} \quad (8)$$

The Maximum throughput is calculated using the following Eq. (9) [3]:

$$Max. \text{ throughput} = \frac{8x}{Delay(x)} \quad (9)$$

where x is the payload in bytes.

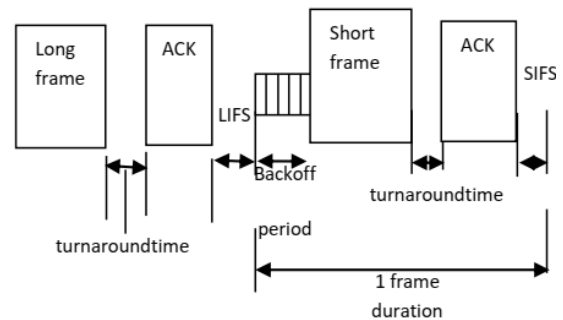


Fig. 4. Frame transmission sequence.

3.2. Network Assumptions

The simulation analysis of the modeled WSN which are connected under the following assumptions, are considered parameters. The network topology is star where one node and one coordinator are used (i.e., single transmitter and receiver). The payload has been increased from 0 byte to 120 bytes and the end to end delay is calculated. Non-beacon and no-Ack mode is used with an

address of 16bit. This procedure has been repeated for 3 nodes, 5 nodes and 10 nodes, the maximum backoff is 5 and the minimum is 3.

Table 6

Network parameters.

Parameters	Values
	Variable
Packet Size (bits)	0, 160, 320, 480, 640, 800, 960
Min. backoff exponent	3
Max. number of backoffs	5
Channel Sensing duration (s)	0.1
Transmit Power (W)	0.05
ACK mechanism	Disable
Destination	Random
Transmission band	2.4 GHz
Simulation time	10 minute
Area	100 X 100 meter
Pan ID Address	16 bit

4. SIMULATION RESULTS

The Opnet modeler (version 14.5) is used to model and simulate different WSN star topology scenarios. It is worth to mention that the Opnet uses object modeling method and graphical editor to provide a simulation environment for the network modeling. Also it has three modeling mechanisms: the bottom is the process model which is responsible of implementing the algorithm agreement; the middle is the node model which uses process model to implement the equipment function; the top mechanism is the network model which uses node model to make network topology structure. This model fully corresponds to the actual protocol, equipment and network, and completely corresponds to the network related features.

4.1. Modeled Network Parameters

The parameters for our Opnet models simulation are used according to Table 6.

Tables of Theoretical and Practical Results

- End to end delay (theoretical)

Table 2

End to end delay (theoretical).

Payload (byte)	1node (msec)	3nodes (msec)	5nodes (msec)	10nodes (msec)
0	1.5152	3.2173	4.9459	9.6021
20	2.1552	3.8573	5.5859	10.2421
40	2.7952	4.4973	6.2259	10.8821
60	3.4352	5.1373	6.8659	11.5221
80	4.0752	5.7773	7.5059	12.1621
100	4.7152	6.4173	8.1459	12.8021
120	5.3552	7.0573	8.7859	13.4421

- End to end delay (simulation)

Table 3

End to end delay (simulation).

Payload (byte)	1node (msec)	3nodes (msec)	5nodes (msec)	10nodes (msec)
0	2	4	4.3	9.1
20	2.7	5.4	6	10
40	3.3	6.5	10	12.4
60	3.9	7.9	11	14
80	4.6	9.2	12.9	15.8
100	5.2	10.5	16	17
120	5.8	11.9	18	19

- Maximum throughput (theoretical)

Table 4

Maximum throughput (theoretical).

Payload (byte)	1node (Kbps)	3nodes (Kbps)	5nodes (Kbps)	10nodes (Kbps)
0	0	0	0	0
20	74.239	41.479	28.644	15.622
40	114.48	71.153	51.398	29.406
60	139.73	93.434	69.911	41.659
80	157.05	110.78	85.266	52.622
100	169.66	124.66	98.209	62.490
120	179.27	136.03	109.27	71.417

- Maximum throughput (simulation)

Table 5

Maximum throughput (simulation).

Payload (byte)	1node (Kbps)	3nodes (Kbps)	5nodes (Kbps)	10nodes (Kbps)
0	118bit	160bit	300bit	600bit
20	59.2	29.6	26	16
40	96.9	49	32	25.8
60	123	60	43	34
80	139	69.5	49	40.5
100	153.8	76	50	47
120	165.5	80.6	53	50.5

4.2. Opnet Network Topology Models and Simulation Results

The network models are designed to study, theoretically and practically, the increasing number of nodes and payload and investigate their effect on end to end delay and throughput particularly in the case of single-hop star topology. Fig. 5 shows the single node (i.e. one transmitter and one receiver) topology Opnet model.

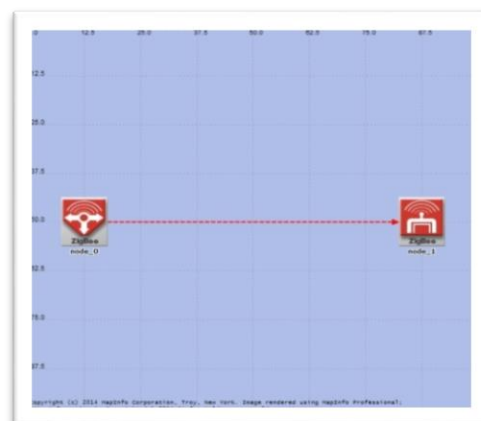
**Fig. 5.** Single node.

Fig. 6 shows that increasing the payload will increase the end to end delay.

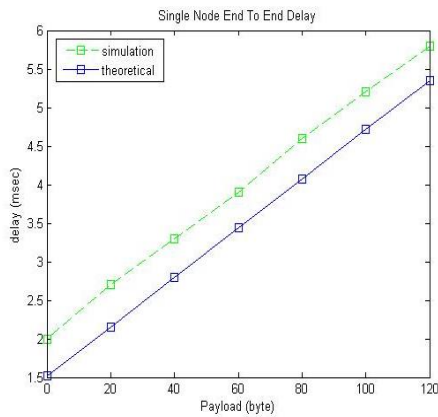


Fig. 6. Single node end to end delay.

The comparison between theoretical and practical results, shows that the practical end to end delay is slightly more 0.5 msec than the theoretical delay; so the conclusion and the main reason behind this, is the theoretical delay. It is assumed that there are no packet losses due to collision and no buffer overflow; while in the practical delay, collision happens when two end devices try to transmit at the same time, therefore the used backoff algorithm affects the delay. On the other hand, increasing the payload will increase the interval time needed to transmit a packet and leads to a higher chance of collision. The throughput is

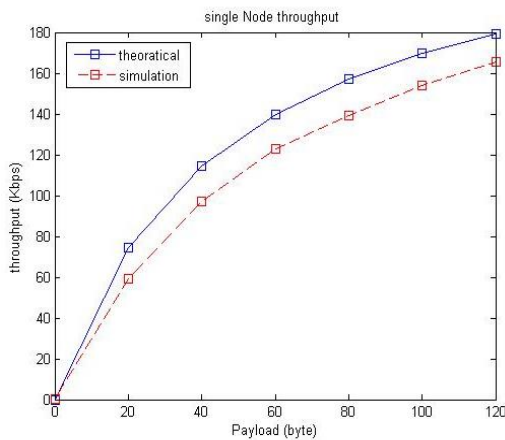


Fig. 7. Single node throughputs

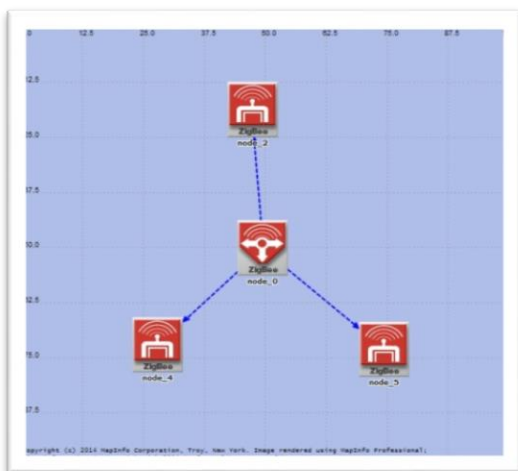


Fig. 8. Connecting 3 nodes.

also affected by this mechanism and from Fig. 7 it can be seen that the throughput decreases when the end to end delay increases. Also the figure shows that increasing the payload will also increase the throughput up to a certain limit (180 Kpbs at 120-byte payload) where it starts to reach its state of saturation and the packet size starts to have higher effects on the end to end delay increase, consequently the throughput decreases significantly. Fig. 8, shows the Opnet model of 3 nodes connected in a star topology. The figure also shows that the theoretical throughput is higher than the practical throughput because the theoretical delay is less than the practical delay for the same reasons mentioned above.

Figs. 9 and 10 show the end to end delay and throughput performance analysis respectively.

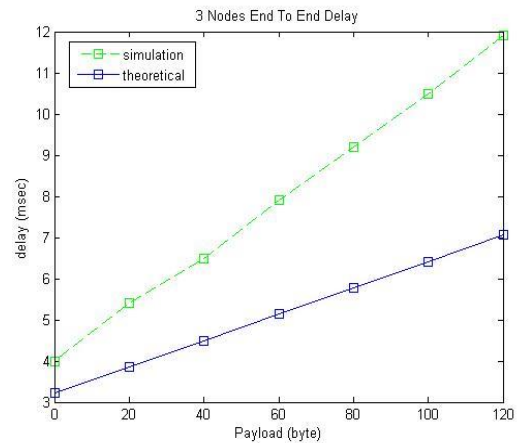


Fig. 9. Three nodes end to end delay.

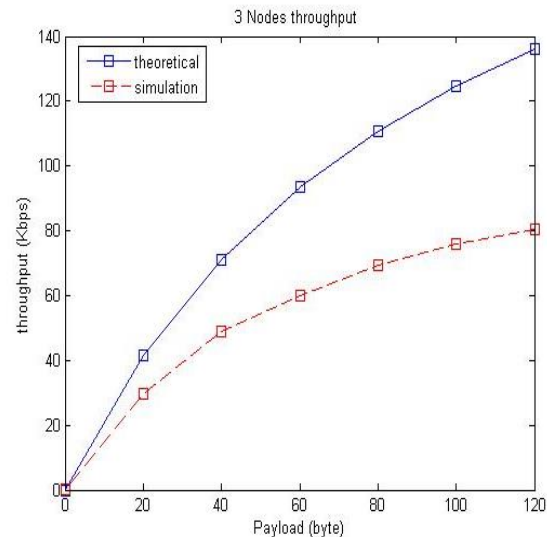


Fig. 10. Three nodes throughput.

As the payload increases (which entails sending more packets or higher number of nodes), it is seen that the difference between the theoretical and practical end to end delay is becoming more obvious and curves are moving apart gradually. As a conclusion it can be said that this is due to the packet collision which contributes more effect on the end to end delay and consequently on the throughput.

Figs. 11 and 12, show the star topology connections of 5 and 10 nodes respectively for the Opnet network modeling.

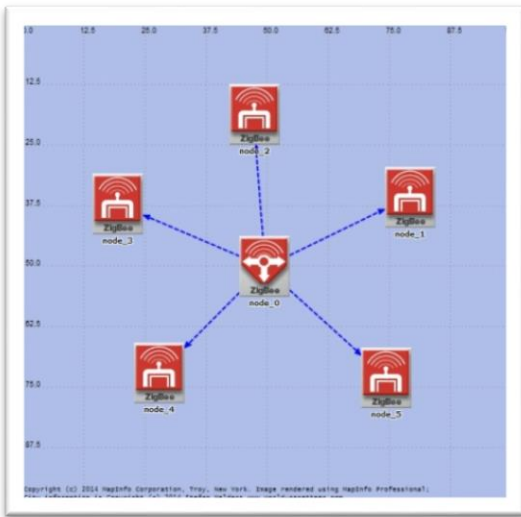


Fig. 11. Five nodes.

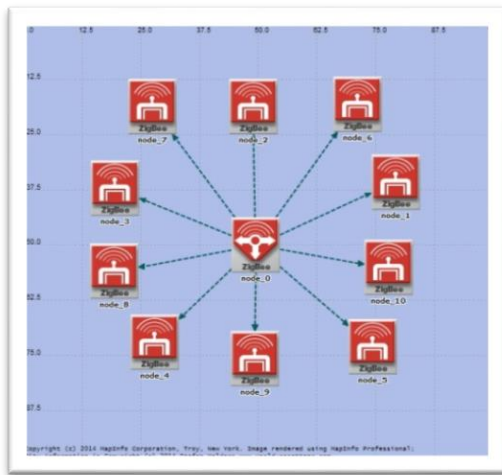


Fig. 12. Ten nodes.

There is a more obvious difference in the end to end delay and throughput in this case due to the increase in the number of nodes and payload, which leads to even higher packet collisions and larger end to end delay with lower throughput performance.

The end to end delay and throughput simulation analysis in Figs. 13-16 show more clearly the random behavior of accessing the channel as the value of payload increases.

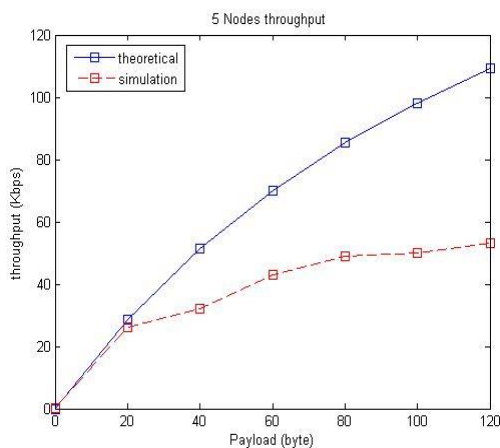


Fig. 13. Five nodes throughput.

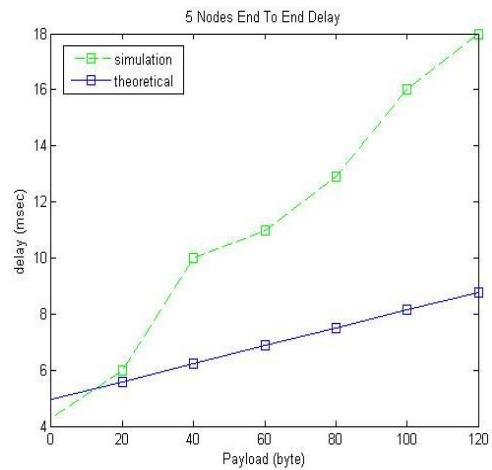


Fig. 14. Five nodes end to end delay.

Also the figures show an acceptable consistence between theoretical and simulation analysis for payload value smaller than 20 bytes, especially for payload larger than 20 bytes. The conclusion and the reason for that is less contention existing at low value of payload and consequently less collision between packets happens.

From Figs. 13 and 15, it can be seen that (at 120 payload) a maximum difference between the theoretical and simulation analysis of (~ 56 & 57) Kbps for 5 and 10 nodes respectively. It worth to mention that Figs. 14 and 16 show a maximum end to end delay (18 and 19 msec) for 5 and 10 nodes respectively.

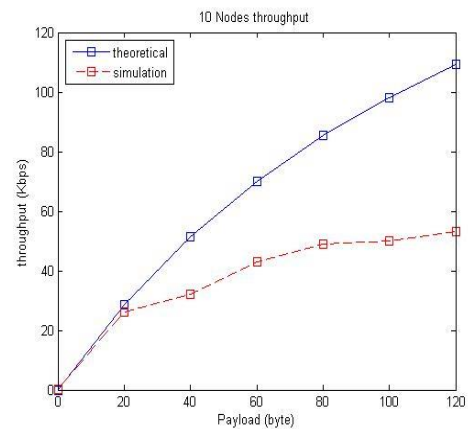


Fig. 15. Ten nodes throughput

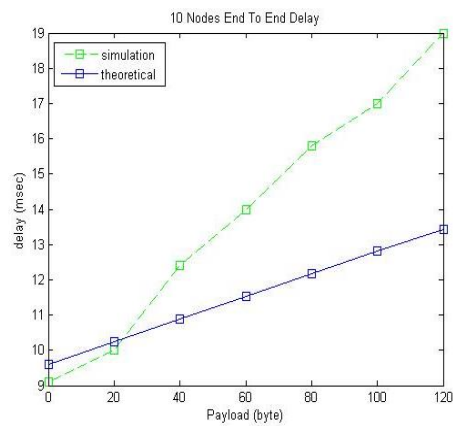


Fig. 16. Ten nodes End to End Delay

5. CONCLUSIONS

In this paper the designed models are simulated to trace the effect of changing the number of nodes and payload on end to end delay and throughput performance. It is found that the average throughput decreases and the delay increases on increasing the number of nodes due to higher collision ratio. The theoretical results differ from that of the practical results because in the former it is assumed that there is no loss of packets due to collision. It can be concluded that it is better to use 40-60 byte payload in the design of a large network (larger than 10 nodes) for the results will be more effective at these values because there is a convergence between the theoretical and practical results. The delay is less, at these values and consequently a better throughput value can be obtained which is very useful for medical or other applications that need a less delay especially when slotted CSMA\CA can't be used.

REFERENCES

- [1] Sun Y, Xu P, Liu H. Performance analysis of wireless sensor network based on OPNET. *Communications and Network* 2013; **5**: 512-516.
- [2] Liang JX. Research on energy efficiency technologies of MAC protocols in WSN based on IEEE 802.15.4. M.Sc. Thesis. Xidian University; 2010.
- [3] Latré B, Mil PD, Moerman I, Dierdonck NV, Dhoedt B, Demeester P. Maximum throughput and minimum delay in IEEE 802.15.4. Springer 2005;866-876.
- [4] Liang X, Balasingham I. Performance analysis of IEEE 802.15.4 based ECG monitoring network. *7th IATED International Conferences Wireless and Optical Communications* 2007; p. 99-104.
- [5] Timmons NF, Scanlon WG. Analysis of the performance of IEEE 802.15.4 for medical sensor body area networking. *IEEE Communications Society Conference on Sensor and Ad Hoc Communications and Networks* 2004; p.16-24.
- [6] Chaari L, Kamoun L. Performance analysis of IEEE 802.15.4/Zigbee standard under real time constraints. *International Journal of Computer Networks and Communication* 2011; **3**: 235-251.
- [7] Kohvakka M, Kuorilehto M, Hännikäinen M, Hämmäläinen TD. Performance analysis of IEEE 802.15.4 and ZigBee for large-scale wireless sensor network applications. *Sensor and Ubiquitous Networks* 2006; 48-57.
- [8] Woon WTH, Wan TC. Performance evaluation of IEEE 802.15.4 Ad Hoc wireless sensor networks: simulation approach. *IEEE Conference on Systems, Man and Cybernetics* 2006; p. 1443-1448.